



HM-TP74-25SVF/W-G40

Handheld Thermography Camera

HIKMICRO G40 handheld camera is specially designed for temperature measurement. It's equipped with a 480 × 360 resolution HIKMICRO thermal detector and a 8MP resolution optical detector. It helps the staff to quickly find the high temperature targets in the environment. Meanwhile it provides assistant decision and ensures safety. The device is mainly applied to various industries, such as substation, petrochemical plant, and machining factory, etc.

Key Features

- High sensitivity thermal module with 480 × 360 resolution
- Leading thermal image processing technology: Adaptive AGC, DDE, 3D DNR
- Supports multiple palettes
- High quality optical module with 8 MP resolution
- Bi-spectrum image fusion, picture-in-picture preview
- Wide temperature measurement range: -20 to 650°C
- High temperature measurement accuracy: Up to $\pm 2^{\circ}\text{C}$, $\pm 2\%$
- High-calibre 800 × 480 resolution 4.3" LCD touch display
- Long-distance laser light supplement for thermography targets
- LED light supplement makes the device a torch in required scenarios
- Supports 1x, 2x, 4x, and 8x digital zoom
- Capture and combines 4x the data to 960 × 720

Specification

THERMAL MODULE	
DETECTOR TYPE	Vanadium Oxide Uncooled Focal Plane Array
IR RESOLUTION	480 × 360 (172,800 pixels)
SUPER RESOLUTION	Capture and combines 4x the data to 960 × 720 (691,200 pixels)
DETECTOR PITCH	17 μm
SPECTRAL RANGE	8 μm to 14 μm
NETD	< 35mk (@25°C, F# = 1.0)
FOV (FIELD OF VIEW)	18.7° × 14°
IMAGE FREQUENCY	50 Hz
FOCAL LENGTH	25 mm
FOCUS	Continuous Autofocus/Autofocus/Manual Focus/Laser Assisted Focus
FOCUS SPEED	Approx. 2 second
MIN. FOCUSING DISTANCE	0.2 m
INTERCHANGABLE LENS OPTIONS	No
IFOV (SPATIAL RESOLUTION)	0.68 mrad, D:S 1470:1
APERTURE	F1.0
OPTICAL MODULE	
BUILT-IN VISUAL CAMERA	3264 × 2448 (8 MP)
FOCUS	Fixed
FOV (FIELD OF VIEW)	65° × 51°
PICTURE RESOLUTION	Configurable: 8MP, 5MP, 2MP
VIDEO RESOLUTION	480 × 360
IMAGE DISPLAY	
DISPLAY	800 × 480 Resolution, 4.3" LCD Touch Screen
SCREEN BRIGHTNESS	Manual
POWER SAVING MODE	Standby Mode, off
DIGITAL ZOOM	1x, 2x, 4x, 8x
COLOR PALETTES	White Hot, Black Hot, Rainbow, Ironbow, Red Hot, Fusion, Rain
IMAGE MODES	Thermal/Optical/Fusion/PIP
PIP	Thermal Picture in Optical Picture
FUSION	Thermal Picture and Optical Picture Combined

LEVEL/ SPAN	Auto/Manual/1-Tap Touch-screen
MINIMUM TEMP SPAN (MANUAL)	2°C (3.6°F)
MEASUREMENT AND ANALYSIS	
OBJECT TEMPERATURE RANGE	-20°C to 650°C (-4°F to 1202°F)
ACCURACY	Max. ($\pm 2^{\circ}\text{C}/3.6^{\circ}\text{F}$, $\pm 2\%$)
MEASUREMENT PRESETS	Center Spot, Hot Spot, Cold Spot, Off
USER-DEFINED MEASUREMENT POINTS	3 points
USER-DEFINED MEASUREMENT LINES	1 line with max./min./avg. temperature
USER-DEFINED MEASUREMENT AREAS	3 areas with max./min./avg. temperature
HIGH TEMPERATURE ALARM	Audible Warning
COLOR ALARM (ISOTHERM)	Above/Below/Interval/Insulation
FOCUS-MODE PALETTES	Above/Below/Interval
ON-CAMERA EMISSIVITY CORRECTION	Variable from 0.01 to 1.0 or selected from the materials list
ON-CAMERA REFLECTED TEMPERATURE COMPENSATION	Automatic, based on the input of the reflected temperature
ON-CAMERA TRANSMISSION CORRECTION	Automatic, based on the inputs for distance and humidity
ON-CAMERA INSPECTION ROUTE	Enabled in the camera, work with HIKMICRO Inspector
STORAGE	
STORAGE MEDIA	Default Storage: Removable SD Card (64 GB); Max. Storage Capacity: 128 GB
IMAGE STORAGE CAPACITY	60,000 Images
IMAGE FILE FORMAT	Radiometric image with Measurement Data Included JPEG Image without Measurement Data Included
VOICE NOTE	Max. 60 Seconds
TEXT NOTE	Max. 200 Characters
VIDEO STORAGE CAPACITY	54 Hours
VIDEO FILE FORMAT	MP4
POWER SYSTEM	
POWER SUPPLY	12 VDC/1.5 A, 5 VDC/2 A (Charging via USB)
POWER CONSUMPTION	5 W
BATTERY TYPE	Dismountable and Rechargeable Li-ion Battery
BATTERY OPERATING TIME	4 Hours Continuous Running

BATTERY CHARGING TIME	4 hours to full charge
BATTERY CHARGING SYSTEM	Two-bay battery charger or in-imager charging, fast charging
AC OPERATION	AC operation with included power supply (100 VAC to 240 VAC, 50/60 Hz)
GENERAL	
WI-FI	802.11 b/g/n (2.4 GHz and 5 GHz)
BLUETOOTH	Bluetooth 4.2
USB INTERFACE	USB Type-C
SD CARD INTERFACE	64 GB SD card
LED LIGHT (TORCH)	Yes
LASER POINTER	Yes
LASER DISTANCE METER	Indoor distance: 50 m (164 ft); Outdoor distance: 10 m (33 ft).
LASER TYPE	Class II, Wavelength: 635 nm; Power: < 1 mW
PROTECTION LEVEL	IP54
DROP TEST HEIGHT	2 m (6.56 ft)
WARRANTY	3 years for full product, 10 years for detector, and 2 years for battery
RECOMMENDED CALIBRATION CYCLE	1 year (assumes normal operation and normal aging)
SAFETY	IEC 61010-1: Overvoltage category II, Pollution Degree 2
ELECTROMAGNETIC COMPATIBILITY	EN55032:2015+A11:2020 EN50130-4:2011+A1:2014 EN61000-3-3:2013
AUSTRALIAN RCM	EN 61010-1: 2010 EN55032:2015+A11:2020 EN50130-4:2011+A1:2014 EN61000-3-3:2013
US FCC	CFR 47, Part 15 Subpart B
ROHS COMPLIANT	Yes
VIBRATION	0.03 g ² /Hz (3.8 g), 2.5 g IEC 60068-2-6
SHOCK	25 g, IEC 68-2-29
WORKING TEMPERATURE RANGE	-20°C to 50°C (-4°F to 122°F)
STORAGE TEMPERATURE RANGE	-20°C to 60°C (-4°F to 140°F)
RELATIVE HUMIDITY	< 95% non-condensing
WEIGHT	Approx. 1000 g (2.20 lb)
DIMENSION	284.7 mm × 118.3 mm × 127.1 mm (11.21" × 4.66" × 5.00")
TRIPOD MOUNTING	UNC ¼"-20

MENU LANGUAGE	21 Languages English, Russian, Hungarian, German, Italian, Czech, Slovak, French, Polish, Portuguese, Spanish, Romanian, Danish, Turkish, Korean, Traditional Chinese, Japanese
SOFTWARE	
PC SOFTWARE	HIKMICRO Analyzer/HIKMICRO Inspector
APP	HIKMICRO Viewer App
CAST SCREEN	UVC Alarm Client

Available Model

HM-TP74-25SVF/W-G40

Dimension

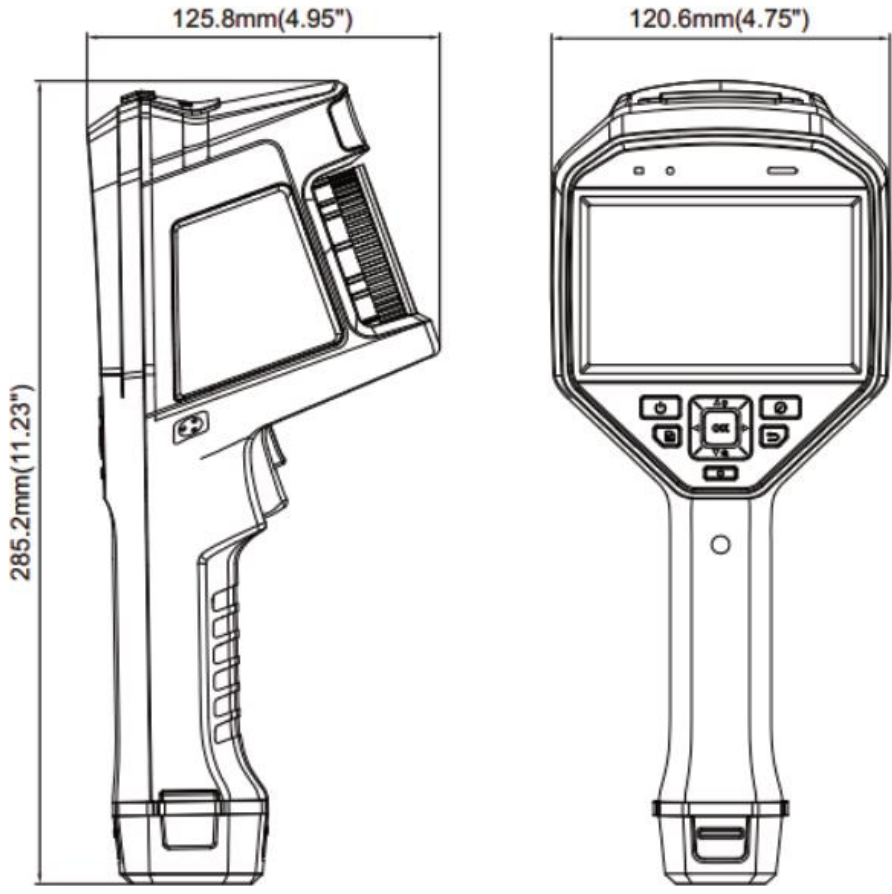

Unit: mm (inch)

Packing List

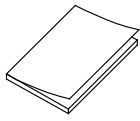

Quick Start Guide (× 1)



Type-C Cable (×1)

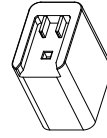

Power Adapter (× 1)

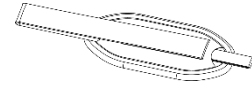

Hand Strap (× 1)

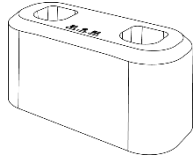

Charging Base (× 1)

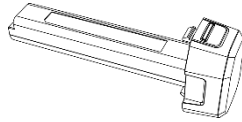

Battery (× 2)

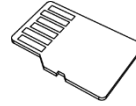

Micro SD Card (× 1)

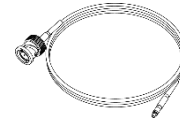

CVBS Cable (× 1)

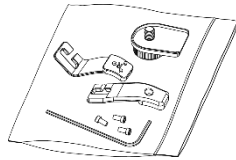

Tools Package (× 1)

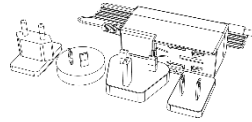

Charger (× 1)

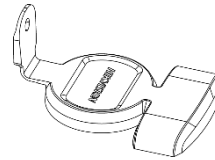

Lens Cover (× 1)

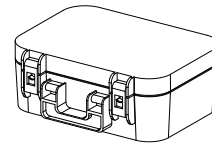

Box (× 1)

Optional Accessories



HM-G630-LENS



HM-G620-LENS



HM-G605-LENS



HM-701ZJ-G01-SHIELD

COMPLIANCE NOTICE: The thermal series products might be subject to export controls in various countries or regions, including without limitation, the United States, European Union, United Kingdom and/or other member countries of the Wassenaar Arrangement. Please consult your professional legal or compliance expert or local government authorities for any necessary export license requirements if you intend to transfer, export, re-export the thermal series products between different countries.



 HIKMICRO Thermography  hikmicro_thermography  HIKMICRO Thermography  HIKMICRO  info@hikmicrotech.com  <http://hikmicrotech.com/en>

room 313, unit B, building 2, 399 danfeng road, xixing subdistrict, binjiang district, hangzhou, zhejiang
@hangzhou microimage software co., Ltd .2020 | data subject to change without notice!